

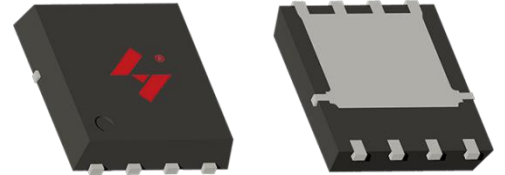

--

-
-
-
-

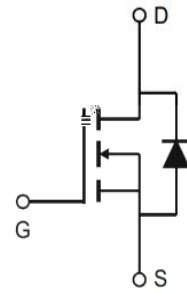

-
-
-



	
---	--

θ				
θ				

.. .

			0 0 1			
				.		
						m
						m

1

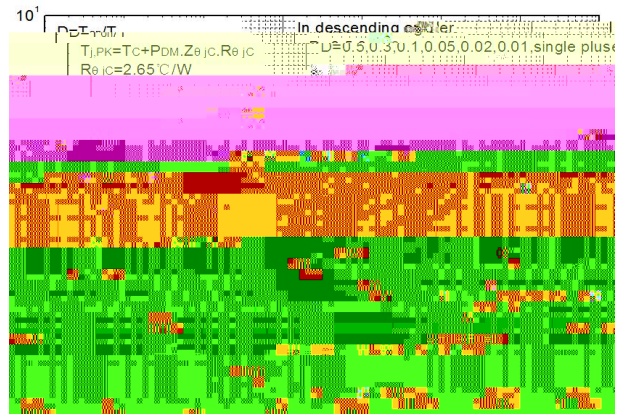
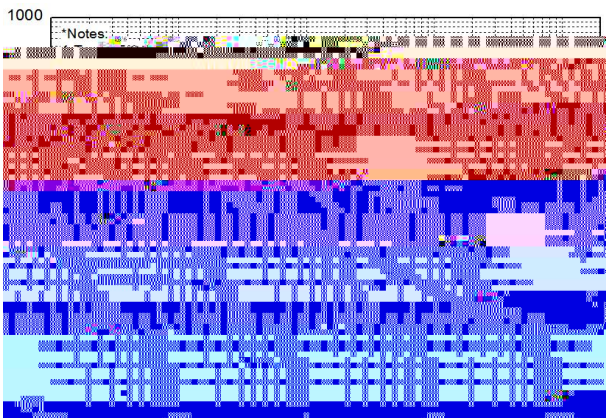
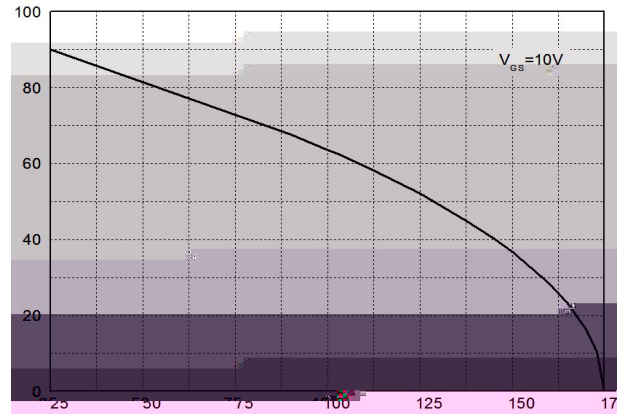
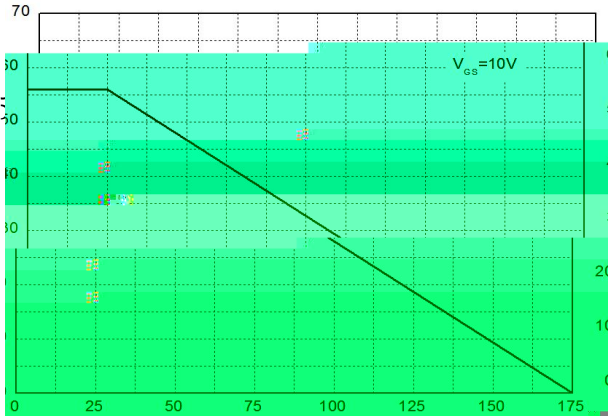

Maximum Effective Transient Thermal Impedance, Junction-to-Case

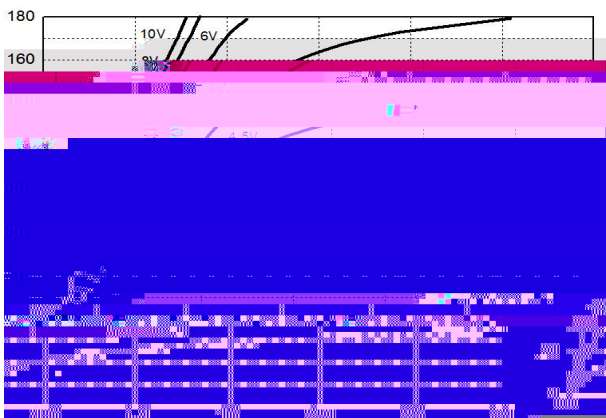

(.)

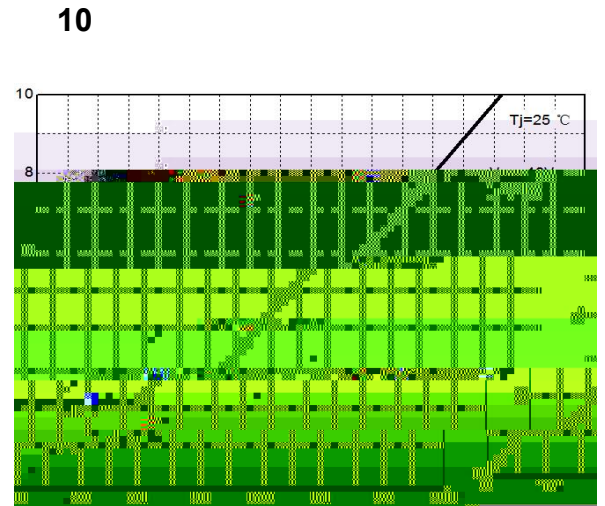
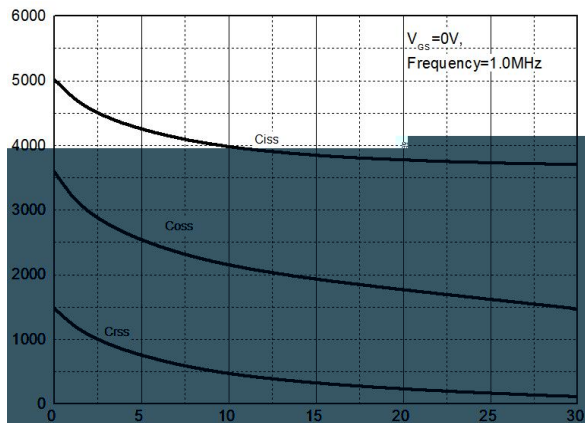
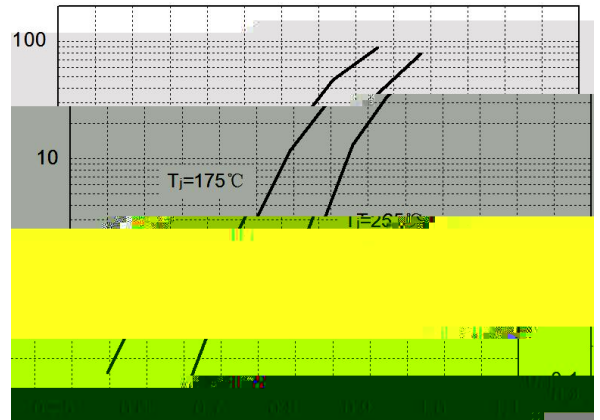
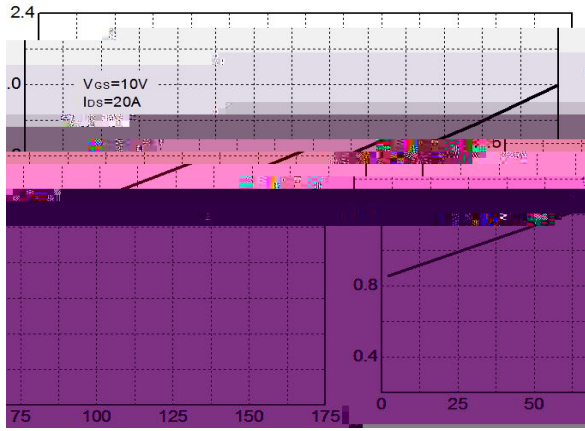

nC

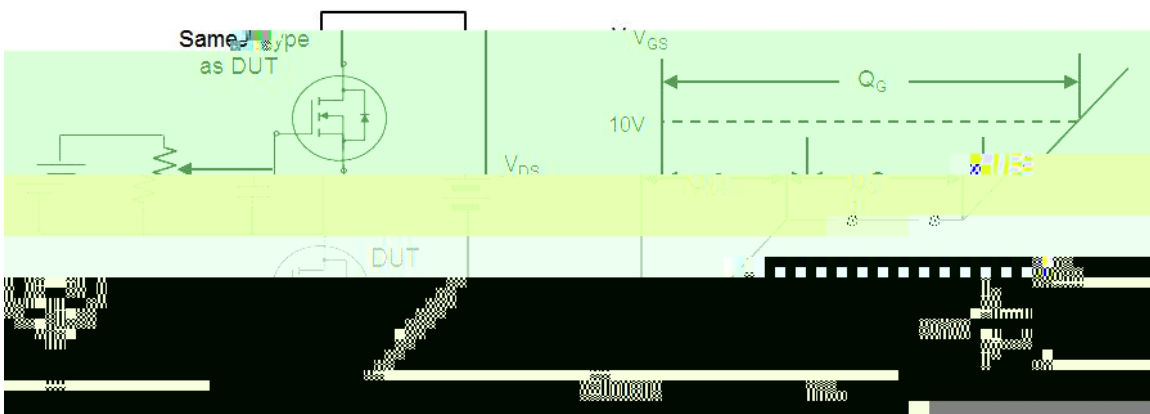
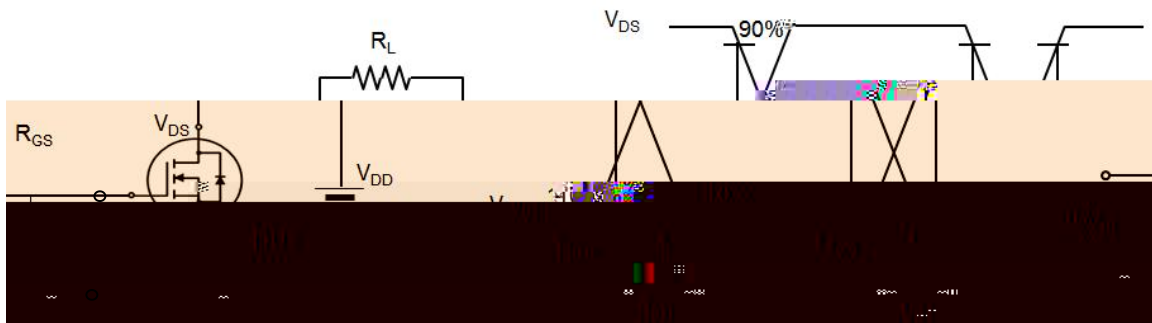
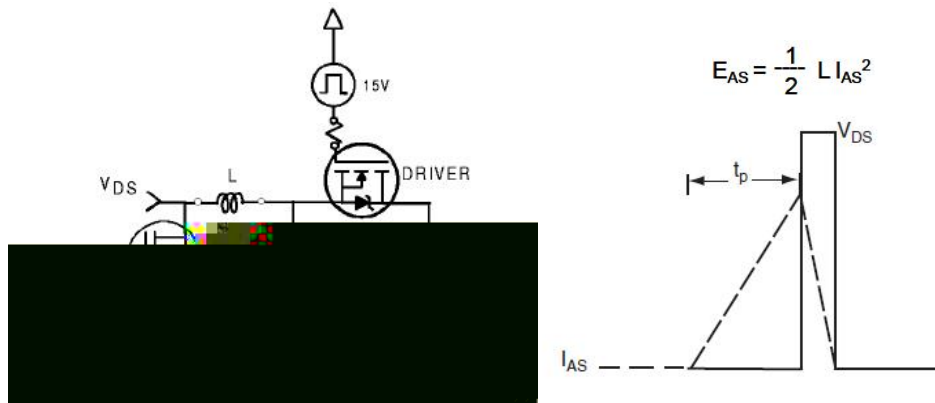

(

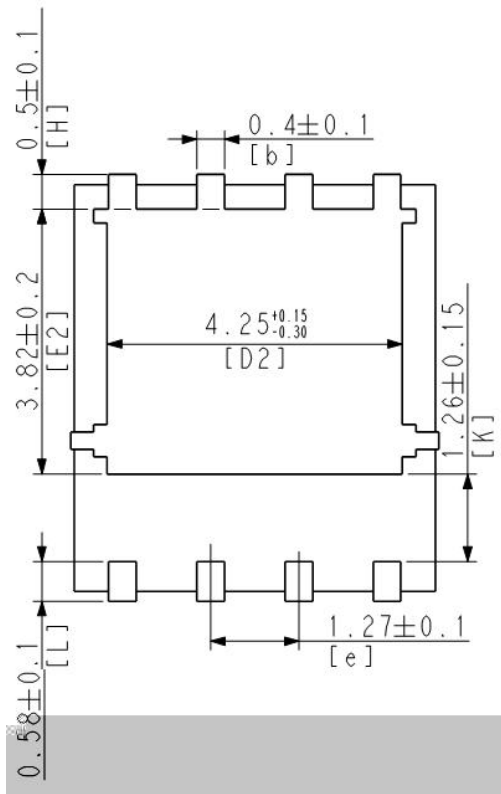
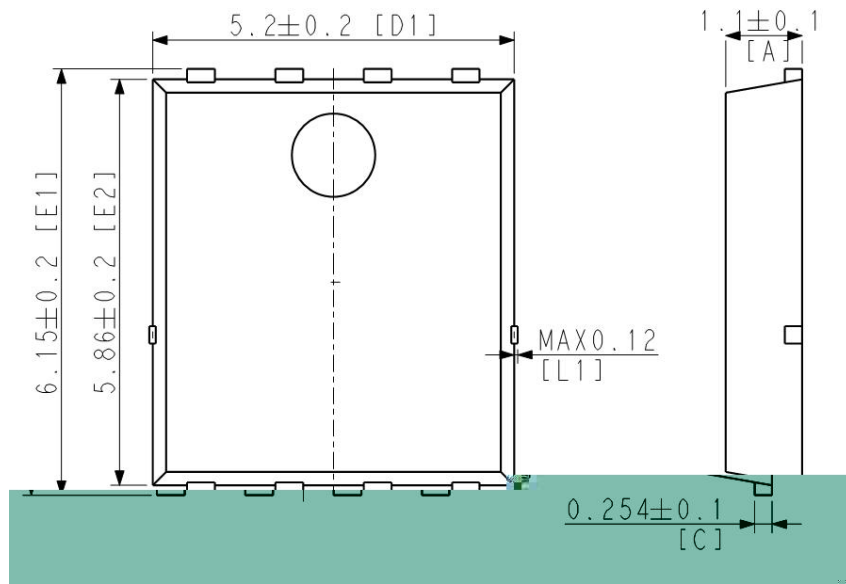

0 0 1

	³ 0	³ 0

	³ 0	³ 0- 000	³ 000
